

Northwest  
Machining & Mfg  
Since 1982  
Meridian Idaho

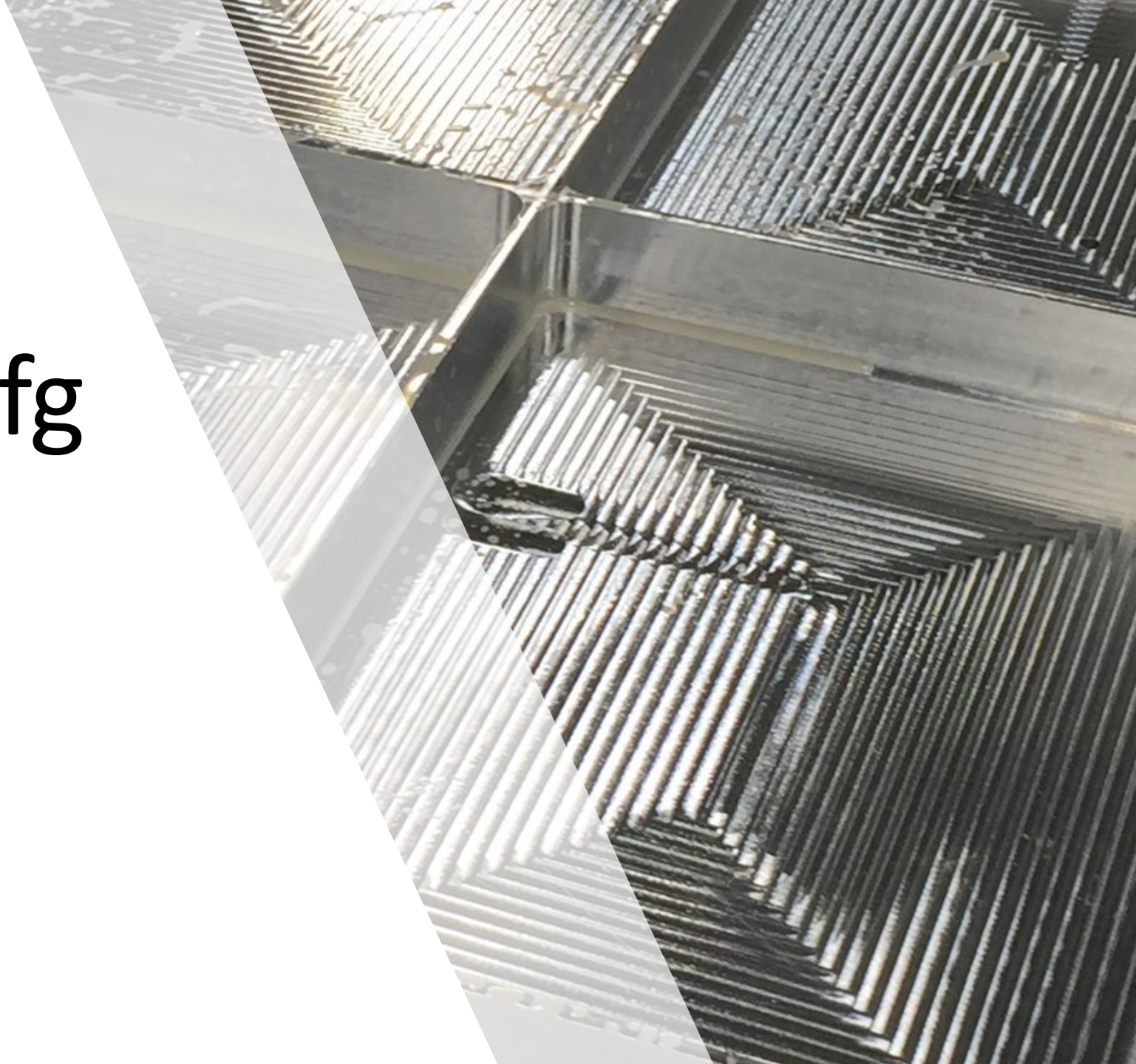

Small Business since 1982

2 Shifts with approx. 50 employees

30,000 Sq. Ft. climate-controlled facility

Annual revenues approx. \$10 Million

Specializing precision machining, tooling & fixturing

For the Aerospace, Defense, and Nuclear industries



# Top Customers

Williams Int  
Triumph Group  
Boeing Defense  
Lockheed Martin  
General Dynamics  
Erickson Air Crane  
Aerojet Rocketdyne  
Northrup Grumman



# Quality System

3 Brown & Sharp CMM's

AS-9100D + ISO-9001:2015

Registered by TUV

DDTC Registered ITAR Certification

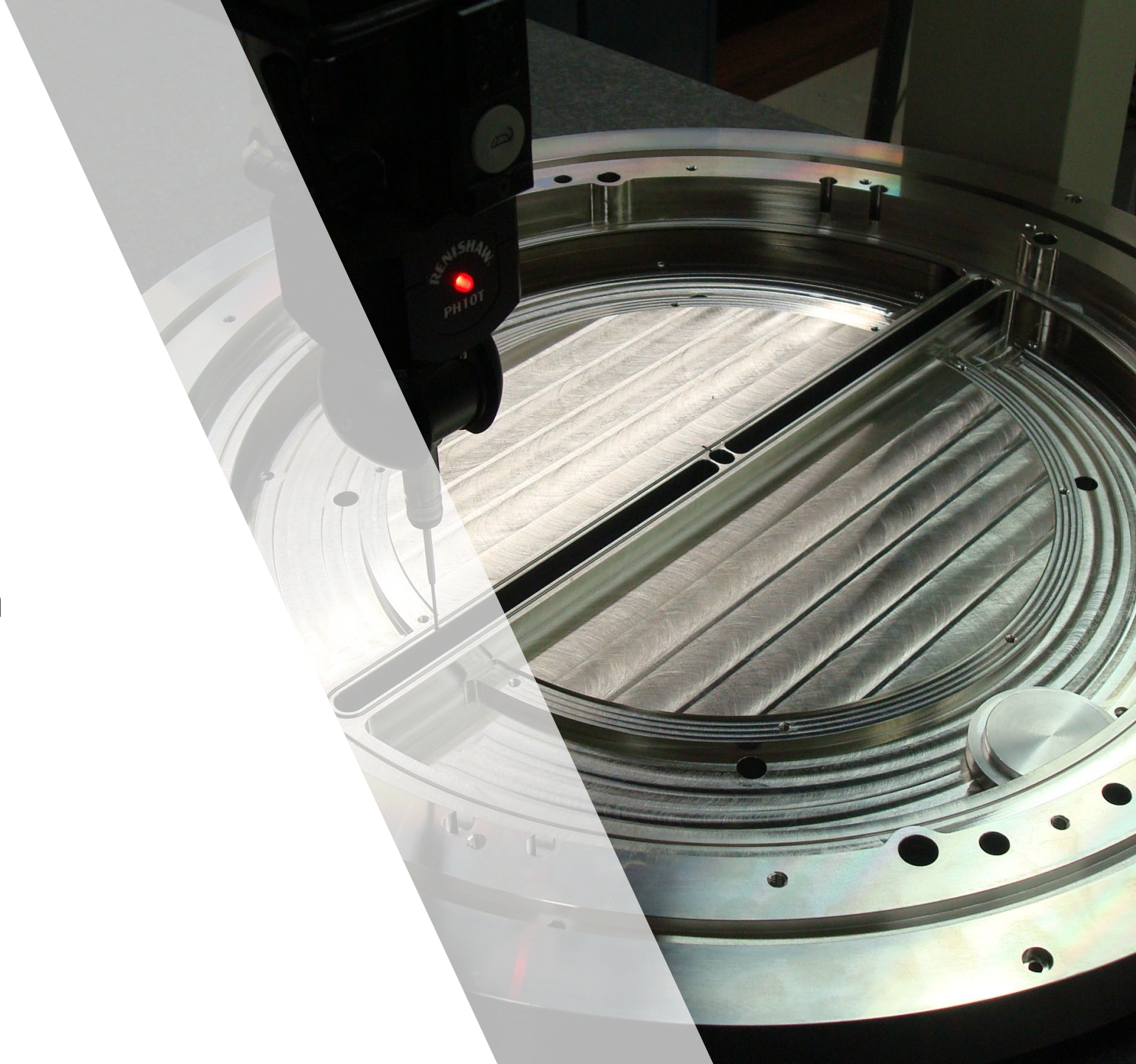



Inspection Lab

2022 Brown & Sharp CMM  
2022 Brown & Sharp CMM  
2015 Brown & Sharp CMM

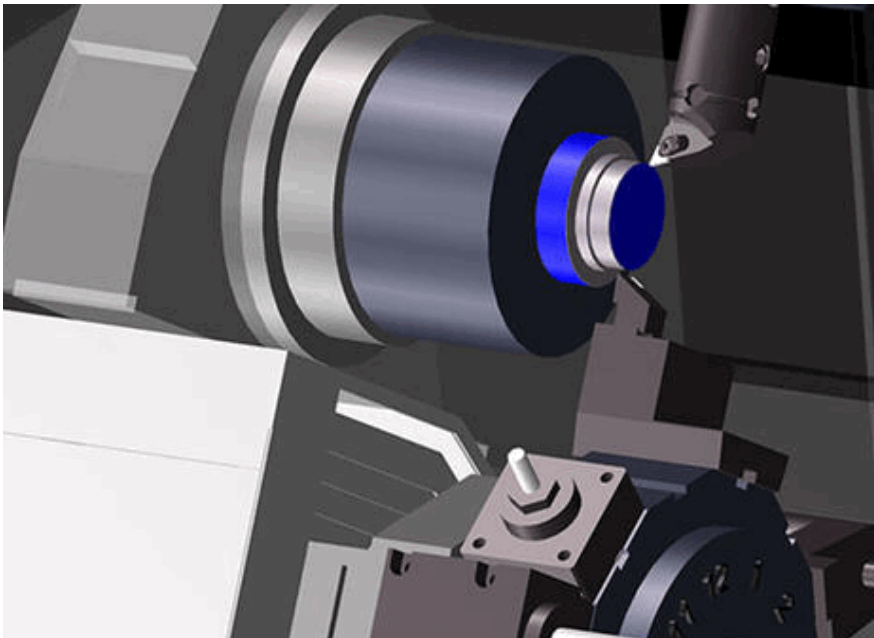

## Digital Infrastructure

Jobboss, Global Search, Unipoint, PC Dmis  
Solid Works, Catia, Gibbs Cam,  
Gibbs, Gibbs 3D Systems (Veri Cut)

This information may be subject to the International Traffic in Arms Regulation (ITAR)

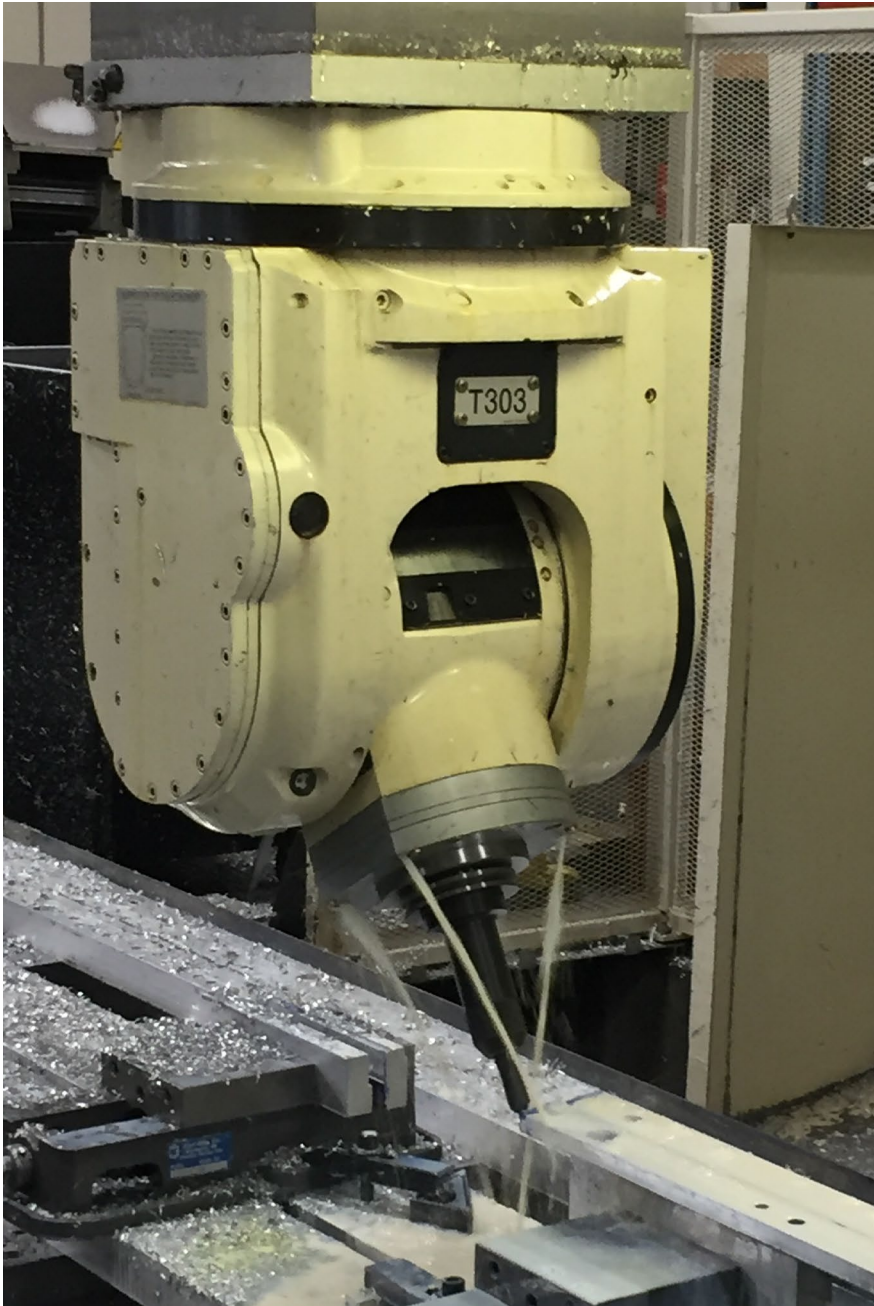

## Multi Axis Milling

5 Axis up to 39.00in cubed

4 Axis 100in x 200in x 60

3 Axis 100in x 200in x 60

This information may be subject to the International Traffic in Arms Regulation (ITAR)

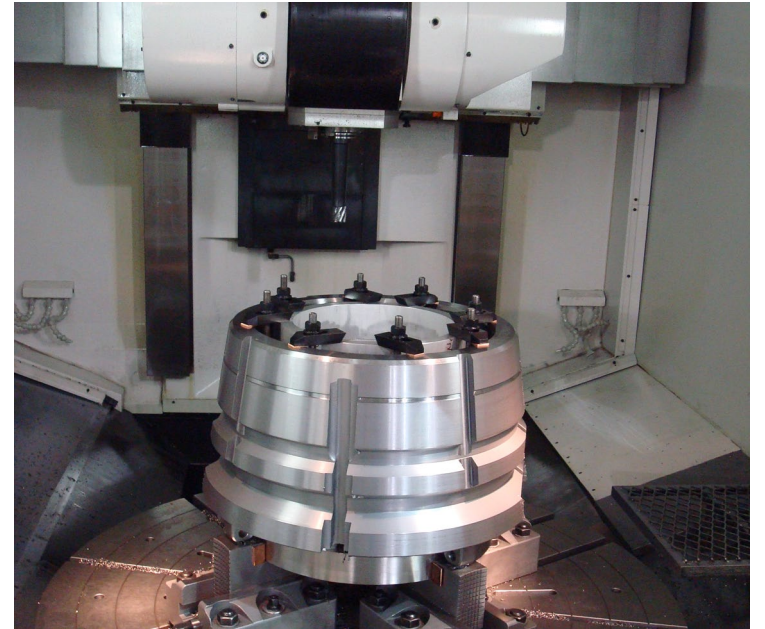

## Multi Axis Turning

3 - 4.5 Axis Turning X 50.0" x Y 19.7" x Z 42.5"  
64in Chuck, Turning up to 58in diameter

---

Manual Turning 36"/24"/45" Gap Swing x 120" BC

This information may be subject to the International Traffic in Arms Regulation (ITAR)



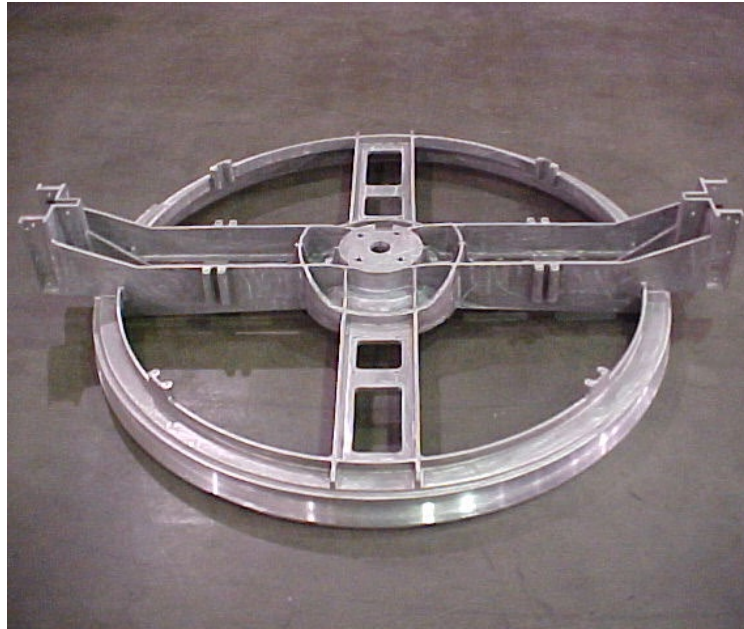

Large Machining

---

108 x 210 x 60 4.5 Axis

This information may be subject to the International Traffic in Arms Regulation (ITAR)

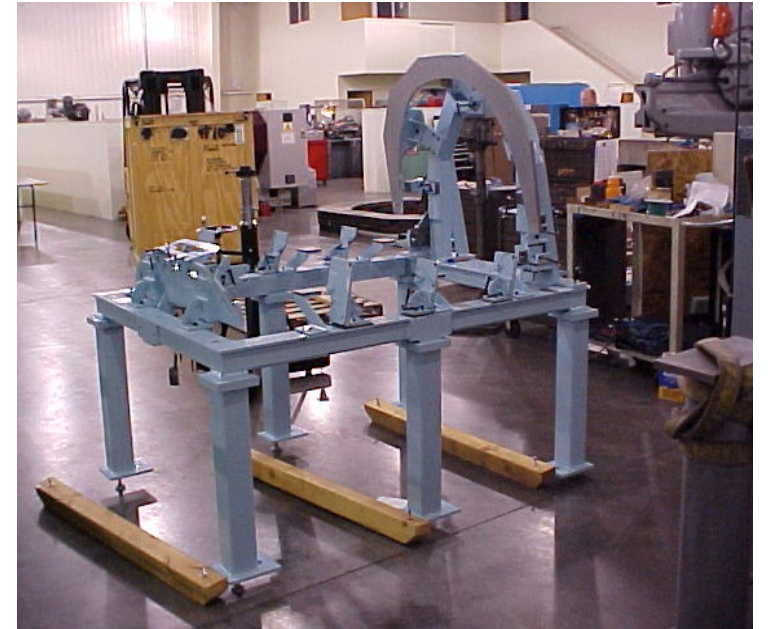
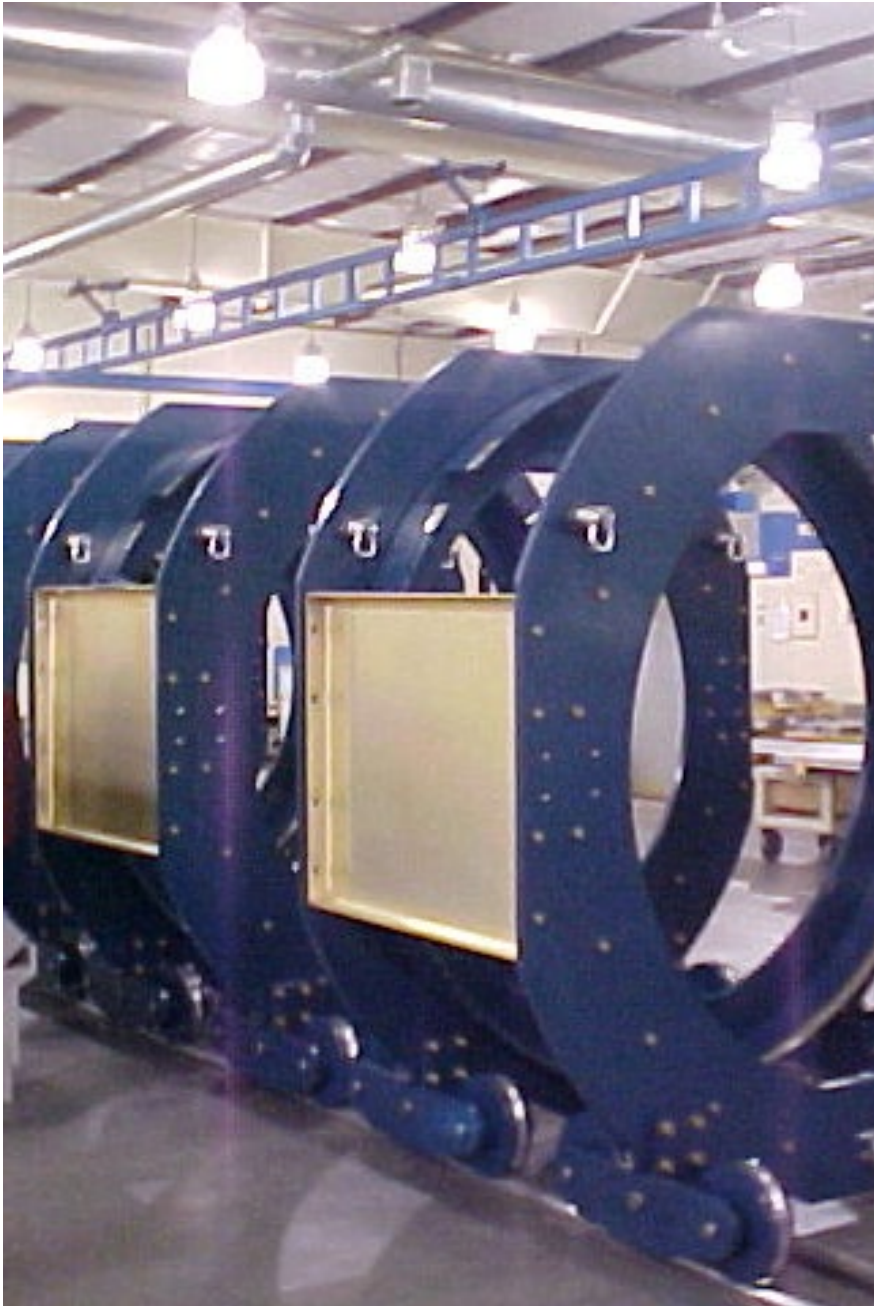

## Ground Support Equipment & tools

Full In house welding and assembly capabilities

Local painting, Load testing,

This information may be subject to the International Traffic in Arms Regulation (ITAR)

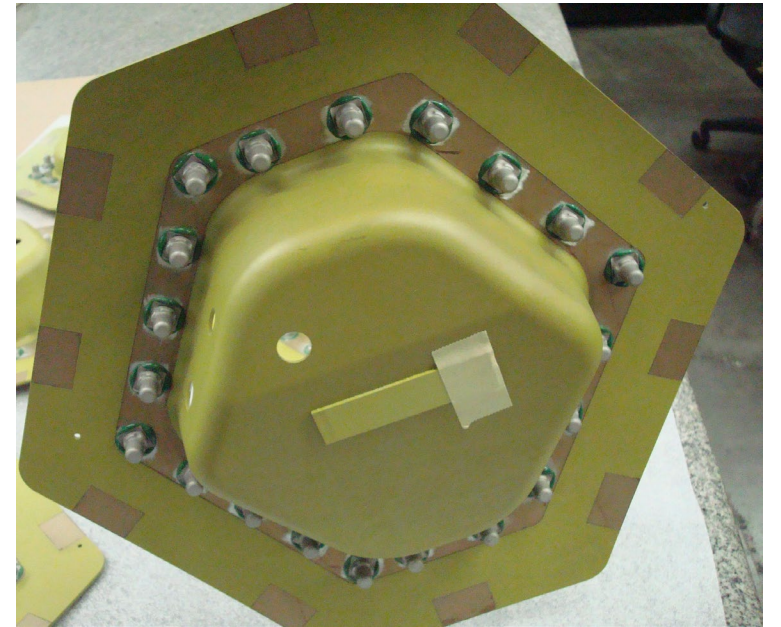

## Bench top Assembly

Bushings, Pins, Rivets, Nut plates,  
HiLocks, Cherry Fasteners, Click Bond

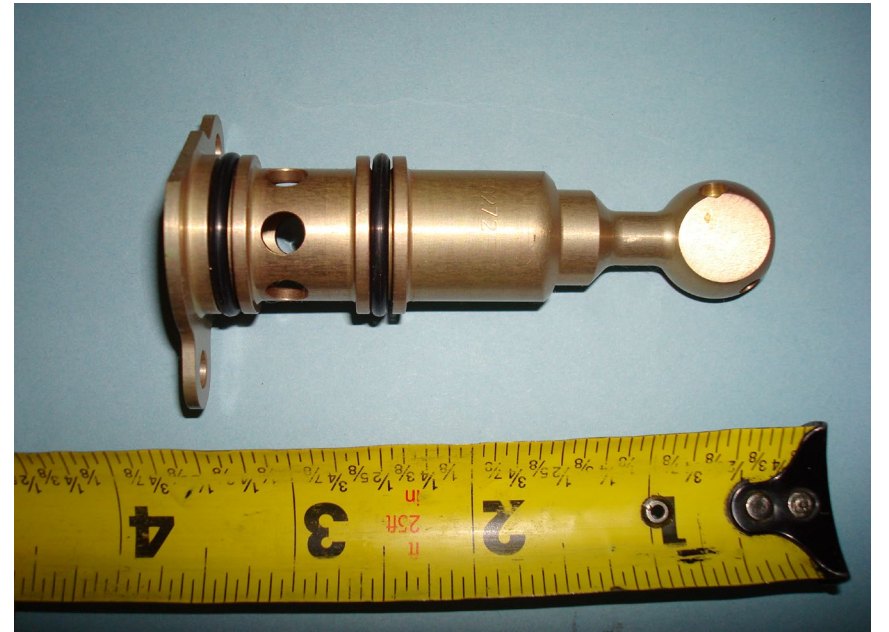

# Small Machining

---

This information may be subject to the International Traffic in Arms Regulation (ITAR)

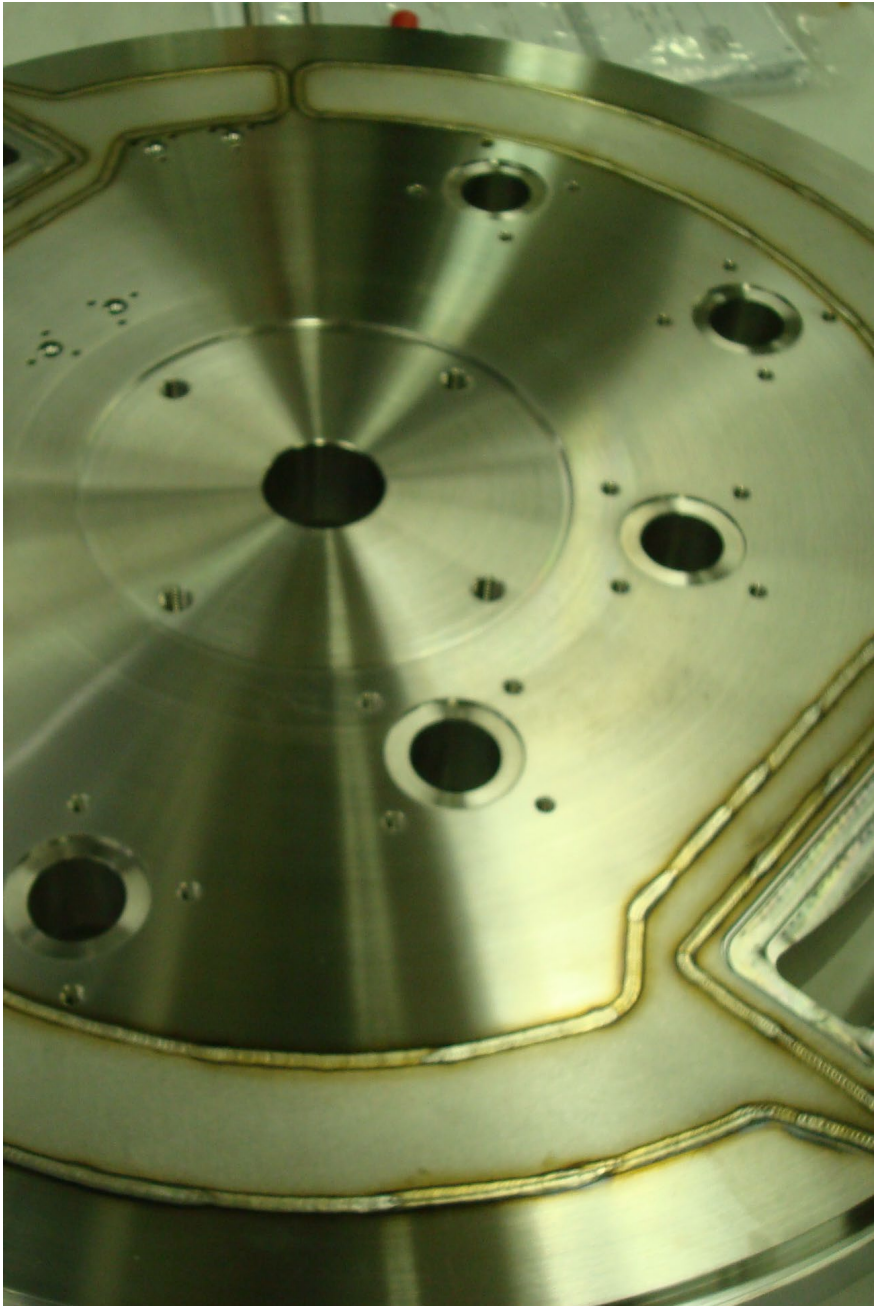

## Welding & Fabrication

LINCOLN PRECISION

375

2006

MILLER

350P

2004

Miller Dynasty 800

800

2017

Rotary Indexers, Load test cell, Stress Relieve oven

This information may be subject to the International Traffic in Arms Regulation (ITAR)

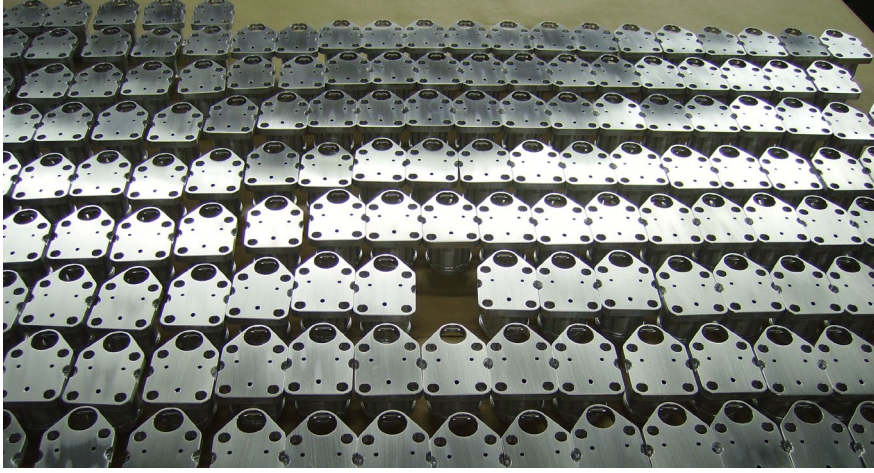

Everything In Between

---

This information may be subject to the International Traffic in Arms Regulation (ITAR)



## Shipping & Receiving

---

NWM will meet all your packaging requirements large or small.

This information may be subject to the International Traffic in Arms Regulation (ITAR)

# 5 Axis Equipment List

OKUMA MILLAC 800VH 2008

MATSUURA MX520-12 2016

MATSUURA MX520-20 2016

OKUMA MACTURN 350-W 2005

OKUMA MU-500VA-L ( Turning ) 2009

OKUMA MU-500VA-L ( Turning ) 2009

OKUMA MU-6300L ( Turning ) 2021

OKUMA MU-6300L ( Turning ) 2022





# 4 Axis Equipment List

OKUMA MX-60 HB 2000

39.37" X 31.49" X 31.88 4 Axis 10,000

OKUMA MA-600HB 2007

39.37" X 35.43" X 39.37" 4 Axis 12,000

MAKINO A55 DELTA 1998

22" X 22" X 22" 4 Axis 14000

MAKINO A55E 2002

22" X 22" X 22" 4 Axis 14000

HITACHI SEIKI HG400III 1997

22" X 20" X 20" 4 Axis 12000

OKUMA MRC-A5 DOUBLE COLUMN 2002

204" X 100" X 60" 4 Axis 6000



# 3 Axis Mills

OKUMA MX-560 2022

40" X 20" X 25" 3 Axis 15000

MAZAK AJV-35/60 1993

60" X 30" X 25" 3 Axis 5000

HITACHI SEIKI VK45II 1997

30" X 19.7" X 19.7" 3 Axis 8000

OKUMA MILLAC 1052 V 2013

80.7" X 33" X 29.5" 3 Axis 6000

OKUMA 4020 2011

40" X 20" X 25" 3 Axis 15000



# Turning Centers

- OKUMA LOC650 / MULTI TURRET 2009  
40.55" SWING/14.375 ID BORE
- OKUMA VTM YB120b 2008  
64.00 CHUCK, MAX TURNING DIA 58.00
- OKUMA LB25II 1998 26" SWING 3 Axis RPM4500
- OKUMA L470 2002 16" SWING 3 Axis
- OKUMA L370M 2001 18" SWING 3+ Axis
- OKUMA L370 2001 18" SWING 3 Axis
- HITACHI SEIKI TS-15 1998 9.8" SWING
- HARDINGE GT 1994 7" SWING 3 Axis
- HARNINGE CONQUEST 1990 9" SWING
- NAKAMURA TOME SLANT 3 1986 24" SWING
- SNK SUT 50 1986 12" SWING 3 Axis 5000
- HARRISON 400 1998 15.75 SWING 3 Axis
- HARRISON 400 1998 15.75 SWING 3 Axis
- POREBA MANUAL LATHE 1998 36" SWING 3 Axis
- HARDINGE HLV-H 11" SWING 3 Axis 3000
- HARDINGE HLV-H 11" SWING 3 Axis 3000
- OKUMA LB-45 2013 25.98 SWING 3 Axis





Thanks for your time